

High Performance BGA Cooling Solutions w/ Thermal Tape Attachment*

DIGI-KEY PART # **ATS1318-ND**

ATS PART # ATS-55230W-C2-R0

Features & Benefits

High efficiency cross-cut fin design provides low pressure drop characteristics

Large surface area increases heat sink performance

Designed for BGAs and surface mount packages

Comes preassembled with high performance thermal interface material

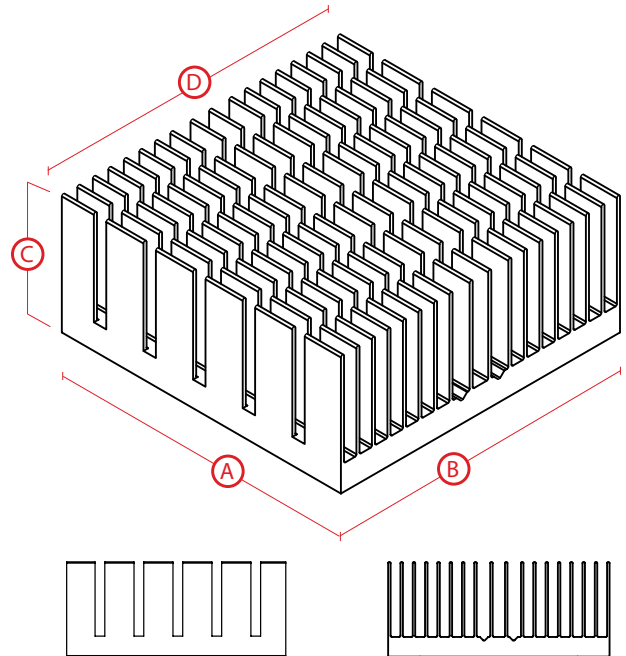

Thermal Performance Table

AIR VELOCITY		THERMAL RESISTANCE	
FT/MIN	M/S	°C/W (UNDUCTED)	°C/W (DUCTED)
200	1.0	6	NA
300	1.5	NA	
400	2.0	NA	
500	2.5	NA	
600	3.0	NA	
700	3.5	NA	
800	4.0	NA	

Product Details†

DIMENSION A	DIMENSION B	DIMENSION C§	DIMENSION D	TIM‡	FINISH
23	23	24.5	N/A	C675	BLACK-ANODIZED

For further technical information, please contact Advanced Thermal Solutions, Inc. at **1-781-769-2800** or **www.qats.com**

* RoHS Compliant

‡ TIM = Thermal Interface Material

† Dimensions are measured in millimeters

◆ Dimensions A & B refer to component size

§ Dimension C = the height of the heat sink shown above and does not include the height of the attachment method



ATS ADVANCED THERMAL SOLUTIONS, INC.

Innovations in Thermal Management®



To place an order, please visit **www.digikey.com**